

# Experimental Techniques in Nuclear and Particle Physics

Bearbeitet von  
Stefaan Tavernier

1st Edition. 2010. Buch. ix, 306 S. Hardcover

ISBN 978 3 642 00828 3

Format (B x L): 15,5 x 23,5 cm

Gewicht: 695 g

[Weitere Fachgebiete > Physik, Astronomie > Quantenphysik > Kernphysik](#)

Zu [Inhaltsverzeichnis](#)

schnell und portofrei erhältlich bei

  
DIE FACHBUCHHANDLUNG

Die Online-Fachbuchhandlung [beck-shop.de](http://beck-shop.de) ist spezialisiert auf Fachbücher, insbesondere Recht, Steuern und Wirtschaft. Im Sortiment finden Sie alle Medien (Bücher, Zeitschriften, CDs, eBooks, etc.) aller Verlage. Ergänzt wird das Programm durch Services wie Neuerscheinungsdienst oder Zusammenstellungen von Büchern zu Sonderpreisen. Der Shop führt mehr als 8 Millionen Produkte.

# Chapter 2

## Interactions of Particles in Matter

The aim of this chapter is to introduce the reader to the different ways subatomic particles interact with matter. For a more in depth discussion of the subject, for references to the original literature, and for a derivation of many of the formula quoted in this chapter, see Ref. [4]. Reference [6, 9] of Chap. 1 are useful web resources containing extensive numerical data on the interactions of subatomic particles in matter.

### 2.1 Cross Section and Mean Free Path

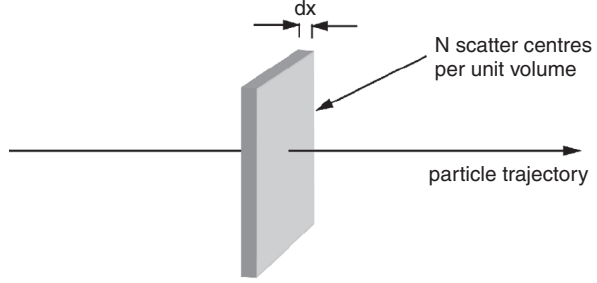
If one of the particles in Table 1.4 travels in any piece of material, it will have a certain probability to interact with the nuclei or with the electrons present in that material. In a very thin slice of matter, this probability is obviously proportional to the thickness of the slice and to the number of potential target particles per unit volume in the material. Furthermore, it will depend on the nature of the interaction. That intrinsic part of the probability is expressed with the help of the quantity ‘cross section’. The cross section is the convenient quantity to discuss the interactions of particles in matter. If a particle crosses perpendicularly through an infinitesimally thin slice of matter, the probability to interact and the cross section  $\sigma$  are related by Eq. (2.1). This equation is the definition of the cross section and it is illustrated in Fig. 2.1.

$$dW = dx N \sigma \tag{2.1}$$

In this equation,  $dW$  is the probability to undergo an interaction of a certain type,  $dx$  is the thickness of a very thin section of the material and  $N$  is the number of scattering centres per unit volume. The cross section has the dimensions of a surface. In nuclear and particle physics, the commonly used units for the cross section are the barn and  $\text{cm}^2$ , with  $1 \text{ barn} = 10^{-24} \text{ cm}^2$ . It is easy to see that, in classical mechanics, the cross section for the collision of a point particle with a hard sphere is just be the surface of a section through the middle of the sphere. This explains the name ‘cross section’.

If a beam of particles enters a slab of material, the number of affected particles in the beam will increase due to the collisions of these beam particles with the nuclei

**Fig. 2.1** Figure illustrating the definition of the cross section



or electrons present in the material. To describe this mathematically, let us define  $P(x)$  as the probability that a particle has interacted after travelling a distance  $x$  in the medium. Obviously, we have  $P(0) = 0$ . From the definition of the cross section (Eq. 2.1), we know that  $P(x + \Delta x)$  and  $P(x)$  are related by

$$P(x + \Delta x) = P(x) + [1 - P(x)] N\sigma \Delta x$$

$$\frac{P(x + \Delta x) - P(x)}{\Delta x} = [1 - P(x)] N\sigma$$

In this expression  $\Delta x$  represents some small distance in the  $x$  direction. Taking the limit  $\Delta x \rightarrow 0$ , we obtain that  $P(x)$  satisfies the following differential equation:

$$\frac{dP(x)}{dx} = [1 - P(x)] N\sigma$$

$$\frac{d[1 - P(x)]}{dx} = -[1 - P(x)] N\sigma$$

The solution of this differential equation, with the boundary condition  $[1 - P(0)] = 1$ , is

$$[1 - P(x)] = e^{-xN\sigma}$$

The probability density function for the interaction of a particle after a travelling distance  $x$  in the medium is given by

$$W(x) = [1 - P(x)] N\sigma = e^{-xN\sigma} N\sigma$$

Therefore, the mean free path  $\lambda$  of a particle before the first collision is given by

$$\lambda = \int_0^{\infty} W(x) x dx = \int_0^{\infty} e^{-xN\sigma} x N\sigma dx$$

$$= \frac{1}{N\sigma} \int_0^{\infty} e^{-x} x dx = \frac{1}{N\sigma}$$

If the material contains two different types of scattering centres,  $X$  and  $Y$ , the above discussion generalises to

$$\lambda = \frac{1}{N_x \sigma_x + N_y \sigma_y}$$

and

$$\begin{aligned} \frac{1}{\lambda} &= \frac{1}{\lambda_X} + \frac{1}{\lambda_Y} \\ \lambda_X &= \frac{1}{N_X \sigma_X}; \lambda_Y = \frac{1}{N_Y \sigma_Y} \end{aligned} \quad (2.2)$$

$N_X$  and  $N_Y$  are the number of scattering centres of each type per unit volume.

If we consider collisions on the nuclei of atoms,  $N$  represents the number of atoms per unit volume. The relative atomic weight  $A_r$  of an element is defined as the average weight of the atoms divided by 1/12th of the weight of carbon. 'A<sub>r</sub>' gram of an element contains  $N_A$  scattering centres, where  $N_A$  is the number of Avogadro. One gram of the material contains  $N_A/A_r$  atoms, and one cubic metre contains  $\rho N_A/A_r$  atoms. We thus have

$$N = \frac{\rho N_A}{A_r}$$

A particle can have different ways to interact. For example a proton can scatter elastically from a nucleus, or it can scatter and bring the nucleus in an excited state. The cross section corresponding to a particular type of interaction is called a partial cross section, and the sum of all partial cross sections is the total cross section. One can also consider the partial cross section where the proton is scattered in a particular direction. This is called a differential cross section and this is usually written as  $d\sigma/d\Omega$ , where  $d\Omega = \sin \theta d\theta d\varphi$ . The total cross section is then given by

$$\sigma_{tot} = \int \frac{d\sigma}{d\Omega} d\Omega$$

## 2.2 Energy Loss of a Charged Particle due to Its Interaction with the Electrons

When a charged particle penetrates in matter, it will interact with the electrons and nuclei present in the material through the electromagnetic force. If the charged particle is a proton, an alpha particle or any other charged hadron (discussed in Chap. 1), it can also undergo a nuclear interaction and this will be discussed in Sect. 2.5. In the present section we ignore this possibility. If the particle has 1 MeV or more as energy, as is typical in nuclear phenomena, the energy is large compared to the binding energy of the electrons in the atom. To a first approximation, matter can be

seen as a mixture of free electrons and nuclei at rest. The charged particle will feel the electromagnetic fields of the electrons and the nuclei and in this way undergo elastic collisions with these objects.

The interactions with the electrons and with the nuclei present in matter will give rise to very different effects. Let us assume for the sake of definiteness that the charged particle is a proton. If the proton collides with a nucleus, it will transfer some of its energy to the nucleus and its direction will be changed. The proton is much lighter than most nuclei and the collision with a nucleus will cause little energy loss. It is easy to show, using non-relativistic kinematics and energy–momentum conservation, that the maximum energy transfer in the elastic collision of a proton of mass ‘ $m$ ’ with nucleus of mass ‘ $M$ ’ is given by (see Sect. 7.3, Eq. 7.1):

$$\Delta E_{\max} = \frac{1}{2}mv^2 \left( \frac{4mM}{(m+M)^2} \right)$$

If the mass of the proton  $m$  is much smaller than the mass of the nucleus  $M$ , we therefore have

$$\Delta E_{\max} \approx \frac{1}{2}mv^2 \left( 4\frac{m}{M} \right) \quad (m \ll M)$$

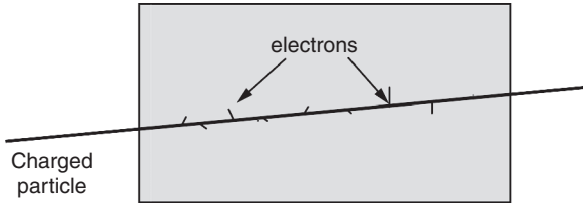
In the limit that the mass of the nucleus goes to infinity, no energy transfer is possible.

In a collision with a nucleus the proton will lose little energy, but its direction can be changed completely; it can even bounce backwards. In collisions with electrons, on the other hand, a large amount of energy can be transferred to the electrons, but the direction of the proton can only be slightly changed. Indeed, there is a maximum possible kinematical angle of deviation in such collisions. It needs a relativistic calculation to derive this angle. As a result, most of the energy loss of the proton is due to the collisions with the electrons, and most of the change of direction is due to the collisions with the nuclei.

A proton, and more generally any charged particle, penetrating in matter leaves behind a trail of excited atoms and free electrons that have acquired some energy in the collision. The energy distribution of these electrons is

$$\frac{dn}{dE} \propto \frac{1}{E^2}$$

Most of these electrons have only received a very small amount of energy. However, some of the electrons acquire sufficient energy to travel macroscopic distances in matter. These high-energy electrons are sometimes called  $\delta$ -electrons. These have sufficient energy themselves to excite or ionise atoms in the medium. This type of energy loss due to the interaction of the charged particle with electrons is often referred to as ‘energy loss due to ionisation’. This is strictly speaking not correct since many atoms are only brought to an excited state, not ionised. Figure 2.2 illustrates the passage of a charged particle in matter and shows some of the ionisation electrons.



**Fig. 2.2** A charged particle penetrates in matter. It loses energy by transferring a small amount of energy to each of a large number of electrons along its trajectory. Some of these electrons have enough energy to travel a macroscopic distance, and also cause further ionisation along their trajectory

When discussing the biological effects of radiation the term ‘Linear Energy Transfer’ (LET) is often used to refer to the energy loss of charged particles. The linear energy transfer is defined as the amount of energy transferred, per unit track length, to the *immediate vicinity* of the trajectory of the charged particle. For heavy- and low-velocity particles, the energy loss per unit track length and the LET are the same. For light and fast particles, however, the two quantities differ considerably. Part of the energy loss of an electron of several MeV is used to eject energetic  $\delta$ -electrons from the atoms in the medium. These energetic electrons do not deposit their energy in the immediate vicinity of the track and therefore do not contribute to the LET.

The energy loss of a high-energy charged particle in matter due to its interactions with the electrons present in the matter is given by the Bethe-Bloch equation:

$$\frac{dE}{dx} = \rho \frac{Z_{\text{nucl}}}{A_r} (0.307 \text{ MeVcm}^2/\text{g}) \frac{Z^2}{\beta^2} \left[ \frac{1}{2} \ln \left( \frac{2m_e c^2 \beta^2 \gamma^2 T_{\text{max}}}{I^2} \right) - \beta^2 - \frac{\delta(\beta)}{2} \right] \quad (2.3)$$

See for example Ref. [4] for the derivation of this equation. The symbols used in the above equation are defined below:

$dE/dx$  = energy loss of particle per unit length

$Z$  = charge of the particle divided by the proton charge

$c$  = velocity of light

$\beta\gamma$  = relativistic parameters as defined in Sect. 1.3

$\rho$  = density of the material

$Z_{\text{nucl}}$  = dimensionless charge of the nuclei

$A_r$  = relative atomic weight

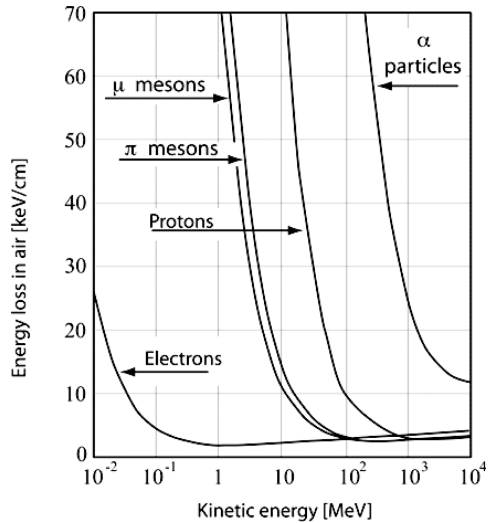
$I$  = mean excitation energy in eV. Parameter usually determined experimentally.

It is typically around (10 eV times  $Z_{\text{nucl}}$ )

$T_{\text{max}}$  = maximum energy transfer to the electron. For all incoming particles except the electron itself this is to a good approximation given by  $\approx 2 m_e c^2 \beta^2 \gamma^2$ . For electrons  $T_{\text{max}}$  is the energy of the incoming electron.

$\delta\beta$  = density-dependent term that attenuates the logarithmic rise of the cross section at very high energy. See (Ref. [6] in Chap. 1) for a discussion of this term.

**Fig. 2.3** Energy loss in air vs. the kinetic energy for some charged particles. Figure calculated using Eq. (2.3)



For the purpose of a qualitative discussion the Bethe–Bloch equation can be approximated as

$$\frac{dE}{dx} \approx \rho (2 \text{ MeV cm}^2 / \text{g}) \frac{Z^2}{\beta^2} \quad (2.4)$$

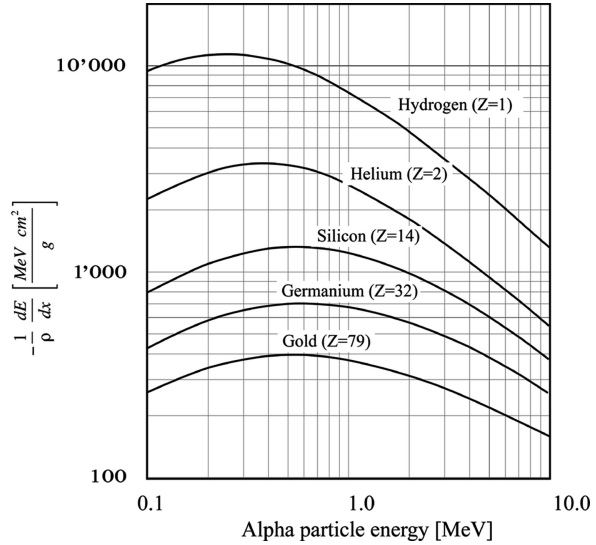
If the density is expressed in  $\text{g/cm}^3$ , the energy loss is in units  $\text{MeV/cm}$ . In the literature, the term ‘energy loss’ sometimes refers to the loss divided by the density. In the latter case, the energy loss has the units  $\text{MeV cm}^2/\text{g}$ . For electrons with energy of more than 100 keV, the velocity is close to the velocity of light ( $\beta \approx 1$ ), and the energy loss is about 2  $\text{MeV/cm}$  multiplied by the density of the medium.

For all particles, the energy loss decreases with increasing energy and eventually reaches a constant, energy-independent value. That value is approximately the same for all particles of unit charge (see Fig. 2.3).

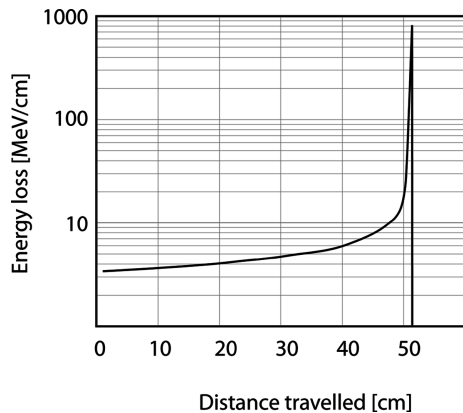
For alpha particles the velocity is usually much less than the velocity of light, and the energy loss is much larger. However, the Bethe–Bloch equation is valid only if the velocity of the particle is much larger than the velocity of the electrons in the atoms, and for alpha particles, this condition is usually not satisfied. The velocity of electrons in atomic orbits is of the order of 1% of the velocity of light. For particle velocities that are small compared to the typical electron velocities in the atoms, the energy loss increases with the energy and reaches a maximum when the particle velocity is equal to the typical electron velocity. After this maximum, the energy loss decreases according to the Bethe–Bloch equation. This behaviour is illustrated in Figs. 2.4 and 2.13.

Since particles lose energy when travelling in a medium, they will eventually have lost all their kinetic energy and come to rest. The distance travelled by the

**Fig. 2.4** Energy loss of alpha particles divided by the density as a function of the alpha particle energy in different materials. Figure adapted from [1]

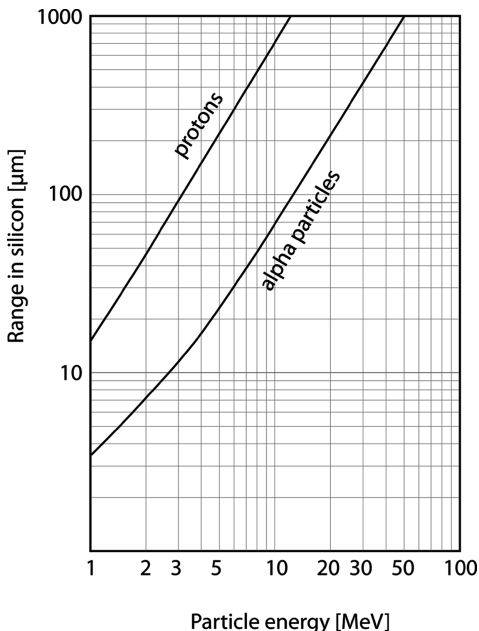


particles is referred to as the range. As the particle penetrates in the medium, its energy loss per unit length will change. The energy loss of a particle as a function of its distance of penetration is illustrated in Fig. 2.5. The energy loss increases towards the end of the range. Close to the end it reaches a maximum and then abruptly drops to zero. This maximum of the energy loss of charged particles close to the end of their range is referred to in the literature as the ‘Bragg peak’, and the variation of the energy loss with the residual energy as the ‘Bragg curve’. However, all the particles with a given kinetic energy do not have exactly the same range. This is due to the statistical nature of the energy loss process. There are fluctuations on the range called range straggling.

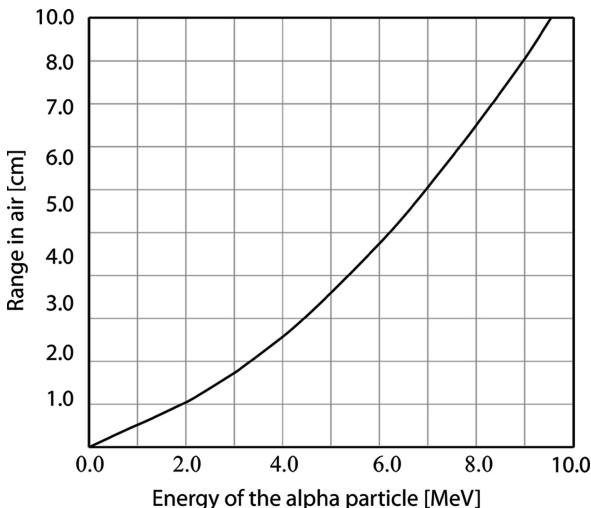


**Fig. 2.5** Energy loss of a proton of 300 MeV along its trajectory in water. The energy loss increases towards the end of the range, reaches a maximum and rather abruptly drops to zero just before the particle stops. The data for this figure were obtained from Ref. [9] in Chap. 1

**Fig. 2.6** Range of protons and alpha particles in silicon as a function of their kinetic energy. The data for this figure were obtained from Ref. [9] in Chap. 1



Heavy nuclear fragments produced by nuclear fission are also energetic charged particles but behave somewhat differently from alpha particles. Nuclear fragments tend to pick up electrons as they travel in the medium. Therefore they behave as particles with a charge that is smaller than the charge of the fragment itself. As they slow down, the fragments pick up more and more electrons, and the energy loss decreases rather than increases. For alpha particles, this electron pick-up only occurs at the very end of the range.



**Fig. 2.7** Range–energy plot for alpha particles in dry air at 20°C and standard pressure. The data for this figure were obtained from Ref. [9] in Chap. 1

$$LET = \frac{1}{\rho} \frac{dE}{dx}$$

Figures 2.6 and 2.7 illustrate the range of particles in air and silicon.

## 2.3 Other Electromagnetic Interactions of Charged Particles

**Multiple scattering.** The collisions of charged particles with the nuclei will cause the charged particle to change direction. This is illustrated in Fig. 2.8. Such erratic changes in the direction of a particle along its trajectory is called direction straggling or multiple scattering. For small angles of deviation, this change in angle is more or less Gaussian and the root mean square (r.m.s.) direction deviation of a particle traversing a thickness  $L$  of material is given by

$$\begin{aligned} \sqrt{\langle \Theta^2 \rangle} &= \frac{Z}{Pc\beta} (20 \text{ MeV}) \sqrt{\frac{L}{X_0}} \\ \frac{1}{X_0} &\approx 4\alpha r_0^2 \frac{\rho N_A}{A_r} Z_{\text{nucl}} (1 + Z_{\text{nucl}}) \ln \left( \frac{183}{\sqrt[3]{Z_{\text{nucl}}}} \right) \end{aligned} \quad (2.5)$$

In this equation  $X_0$  represents the radiation length. This is a quantity that characterises how charged particles or gamma rays interact in a material. It depends on the density and the charge of the nucleus. The simple analytical expression for the radiation length given in Eq. (2.5) is only an approximation. A more exact but much more complicated expression is given in (Ref. [6] in Chap. 1).

The definitions of the symbols used in the multiple scattering formula and in the expression for the radiation length are given below. The other symbols have the same meaning as in Eq. (2.3).

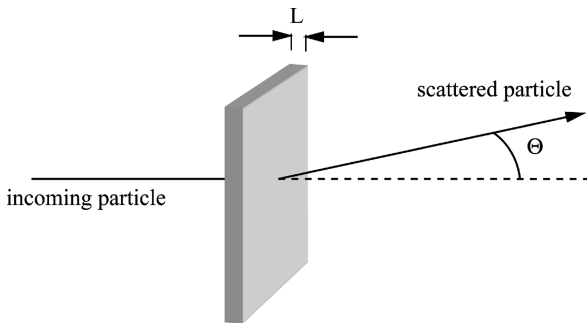
- $\Theta$  = scattering angle relative to the incoming particle in radians
- $P$  = momentum of the incoming particle
- $X_0$  = radiation length of the material
- $N_A$  = Avogadro's number
- $\alpha$  = fine structure constant ( $\alpha \approx 1/137$ )
- $r_0$  = classical electron radius ( $2.82 \cdot 10^{-15}$  m)

Notice that  $\Theta$  represents the angle in space. The symbol  $\Theta_p$  represents the angle projected on a plane containing the direction of the incoming particle. These two quantities are related by

$$\sqrt{\langle \Theta_p^2 \rangle} = \frac{1}{\sqrt{2}} \sqrt{\langle \Theta^2 \rangle}$$

Table 2.1 lists the radiation length for some common materials.

**Fig. 2.8** A charged particle traversing a slice of matter will change direction due to multiple scattering on atomic nuclei



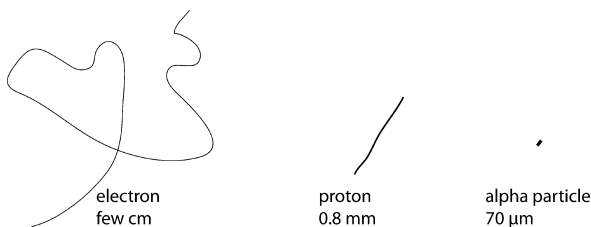
**Table 2.1** Radiation length  $X_0$  for some common materials

Material	Radiation length $X_0$
Air	304 m
Water	36 cm
Shielding concrete	10.7 cm
Nylon	36.7 cm
Aluminium (Al)	8.9 cm
Silicon (Si)	9.36 cm
Iron (Fe)	1.76 cm
Lead (Pb)	0.56 cm
Uranium (U)	0.32 cm

At nuclear energies, the momentum of the particles is of the order of  $Pc \approx 1 \text{ MeV}$ , and particles will, on average, scatter over a very large angle in one radiation length. After one radiation length the information about the original direction is essentially lost. However, alpha particles or protons of a few MeV have a range that is only a very small fraction of the radiation length. Hence, they will stop before they have scattered over a large angle. Electrons, on the other hand, can penetrate to a significant depth in the material, and electrons will therefore be strongly affected by multiple scattering. Figure 2.9 shows typical trajectories for an electron, a proton and an alpha particle of 10 MeV in silicon.

The path of an electron in matter can be several centimetres, but the distance travelled according to a straight line is usually much shorter than the actual length of the trajectory. Electrons do not have a well-defined range. The number of electrons

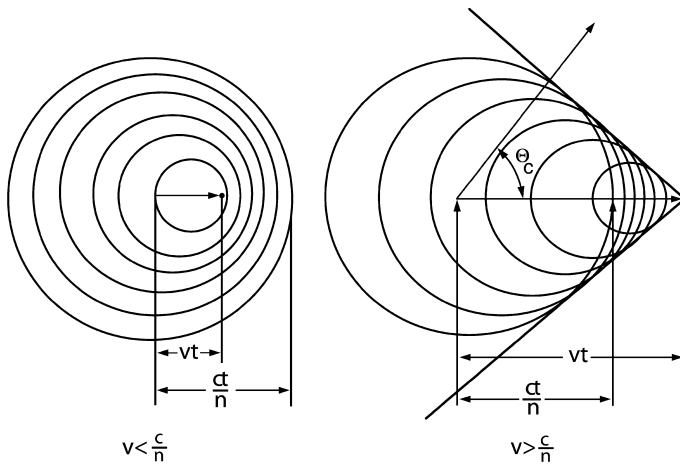
**Fig. 2.9** A typical trajectory for an electron, a proton and an alpha particle of 10 MeV in silicon. The electron trajectory is drawn on a scale 10 times smaller than the trajectory of the proton and the alpha particle



that can penetrate through a slice of material will decrease more or less linearly with the thickness of the slice of material.

**Cherenkov effect.** The Cherenkov effect is a light emission effect that occurs whenever a charged particle travels in a medium faster than the speed of light in that medium. In a medium with optical index of refraction ‘ $n$ ’, the velocity of light is  $c/n$ . Typical values for the refractive index in liquids or solids are around 1.5, and the velocity of light in these materials is about 66% the speed of light. The Cherenkov effect is somewhat similar to the bow wave that accompanies a speedboat in water, or the ‘supersonic bang’ of a plane going at a speed faster than the speed of sound.

This effect is illustrated in Fig. 2.10. This phenomenon is easily understood by following the Huygens’ principle used to explain optical and acoustical phenomena. If a charged particle travels in a medium, the electric field of the charged particle will polarise the medium. After the particle has passed, the medium returns to its original unpolarised state. This change of polarisation condition in the medium represents an electromagnetic perturbation that will propagate in space at the speed of light. The left-hand side of Fig. 2.10 shows the case where the particle travels at a speed lower than the speed of light in the medium. The small electromagnetic perturbations caused by the polarisation and depolarisation of the medium propagate faster than the particles. At any point in space far away from the particle’s trajectory, these perturbations arrive randomly and annihilate each other. The right-hand side of Fig. 2.10 shows the case where the particle travels at a speed faster than the speed of light in the medium. The small electromagnetic perturbations caused by the polarisation and depolarisation of the medium propagate less rapidly than the particles. All the elementary perturbations unite together in one wavefront. The phases between all these elementary perturbations are not randomly distributed. They add up together to produce a finite perturbation. This perturbation represents a wave



**Fig. 2.10** (Left) A particle is travelling at a speed lower than the speed of light in the medium. (Right) A particle is travelling at a speed greater than the speed of light in the medium

travelling in the direction fixed by the speed of the particle and the speed of light in the medium.

From the geometry of the problem, we can easily derive the value of the angle between the particle and the wave. To find this angle, consider the right-angled triangle shown in the left-hand side of Fig. 2.10. Two sides of this triangle are of length  $ct/n$  and  $vt$ , respectively. We therefore have

$$\cos(\theta_c) = \frac{(c/n)t}{vt} = \frac{c}{nv} \quad (2.6)$$

The Cherenkov effect thus consists of the emission of optical photons in the direction given by Eq. (2.6). A similar situation prevails when an airplane is flying at supersonic speed. It is accompanied by a loud acoustical ‘bang’ that propagates in a direction given by a similar equation.

The intensity of the Cherenkov effect can be calculated from first principles by solving the Maxwell equations with the proper boundary conditions. The result of this calculation is

$$\begin{aligned} \frac{d^2E}{d\hbar\omega dx} &= \hbar\omega \frac{Z^2\alpha}{\hbar c} \left[ 1 - \frac{c^2}{n^2v^2} \right] & v > \frac{c}{n} \\ \frac{d^2E}{d\hbar\omega dx} &= 0 & v < \frac{c}{n} \end{aligned}$$

In the above equation, the notation is as follows:

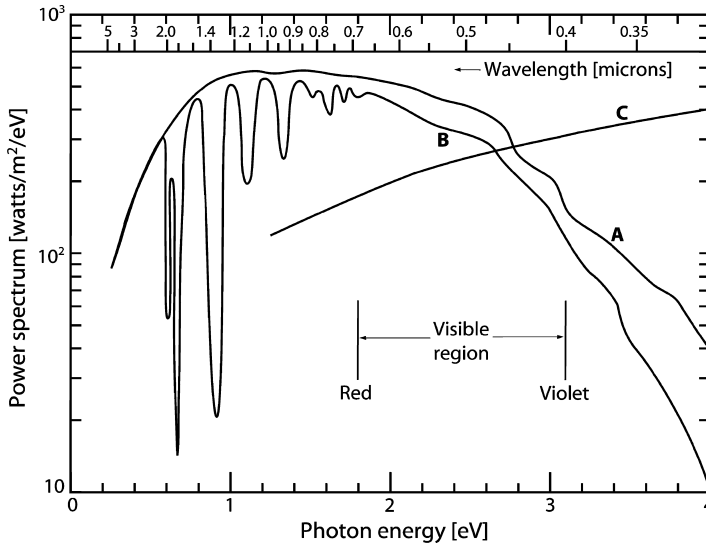
- $Z$  = charge of the particle in units ‘proton charge’
- $E$  = energy emitted in the form of optical photons
- $n$  = optical refractive index
- $c$  = velocity of light in vacuum
- $v$  = velocity of the particle
- $\hbar\omega$  = energy of the emitted photon
- $\alpha$  = fine structure constant (1/137)
- $\hbar c$  = numerical constant of value  $197 \cdot 10^{-9}$  eV m

Dividing Eq. (2.7) by  $\hbar\omega$  gives the number of Cherenkov photons produced per-photon-energy interval and per-unit-length. A high-energy electron produces about 220 photons/cm in water ( $n = 1.33$ ) and about 30/m in air, in the visible part of the spectrum.

From Eq. (1.4), we derive that a charged particle will emit Cherenkov radiation if the kinetic energy exceeds the threshold value given by

$$E_{\text{threshold}} = mc^2 \left( \sqrt{\frac{n^2}{n^2 - 1}} - 1 \right) \quad (2.8)$$

The threshold for the Cherenkov effect of electrons in water is 264 keV. For protons the threshold is 486 MeV. At nuclear energies, only electrons can acquire



**Fig. 2.11** (A) Energy spectrum of sunlight above the atmosphere, (B) Energy spectrum of sunlight at sea level with the Sun at its zenith. (C) Energy spectrum of Cherenkov emission. Figure reproduced from [1], with permission

a speed that exceeds the speed of light in a medium, and therefore emit Cherenkov radiation.

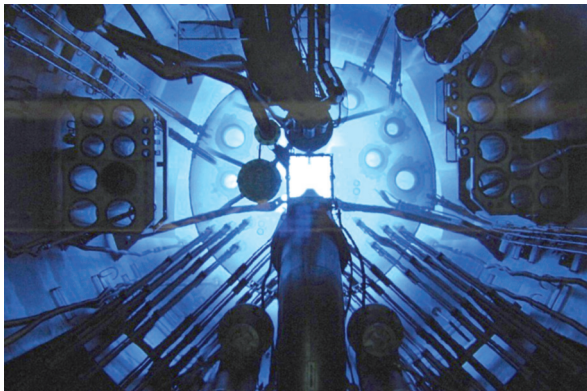
Comparing the energy spectrum of Cherenkov light with the spectrum of solar light, we see that the Cherenkov radiation contains more energy in the blue part of the spectrum; therefore, Cherenkov radiation appears as blue light (see Fig. 2.11). Cherenkov radiation is causing the characteristic blue glow in the water surrounding the core of a water pool reactor, as illustrated in Fig. 2.12.

The Cherenkov effect only represents a small loss of energy compared to the energy loss due to ionisation considered before. It is nevertheless an interesting effect because it depends only on the velocity of the particle. If one knows the energy or the momentum of a particle by other means, measuring the Cherenkov effect allows knowing the mass, and therefore the nature of that particle.

**Transition radiation.** This is a weak effect somewhat similar to the Cherenkov effect. It is also due to the polarisation of the medium by the charged particle. It depends on the plasma frequency in the material. The plasma frequency is usually expressed as a quantity with dimension energy, and it is given by the equation

$$\hbar\omega_p = \sqrt{4\pi N_e r_0^3 m_e c^2 / \alpha}$$

In this equation  $N_e$  is the number of electrons per unit volume in the material,  $r_0$  the classical electron radius and  $\alpha$  the fine structure constant. The plasma frequency  $\hbar\omega_p$  is about 30 eV for materials with density 1.



**Fig. 2.12** The Cherenkov effect is causing the blue glow in the water surrounding the core of a water pool reactor (here the OPAL reactor, Australian Nuclear Science and Technology Organisation). Gamma rays originating from the reactor core convert to electron–positron pairs in the water. Many of these electrons or positrons travel at speeds exceeding the speed of light in water and thus produce Cherenkov radiation. Photograph courtesy of the Australian Nuclear Science and Technology Organisation

Whenever a particle of charge  $Z$  traverses a boundary between vacuum and some material, a small amount of energy is emitted as energetic photons. The power spectrum of these photons is logarithmically divergent at low energy and decreases rapidly for  $\hbar\omega > \gamma\hbar\omega_p$ , where  $\gamma$  is the relativistic  $\gamma$  factor of the particle. About half of the energy is emitted in the form of photons with energy in the range  $\gamma\hbar\omega_p/10$  to  $\gamma\hbar\omega_p$ . The typical energy of the emitted photons is given by

$$E_{\text{typical}} = \gamma\hbar\omega_p/4$$

The average number  $N_\gamma$  of photons with energy larger than  $\gamma\hbar\omega_p/10$  is

$$N_\gamma \approx 0.8 \alpha Z^2 \approx 0.59\%Z^2$$

The total energy emitted by this effect when a charged particle traverses a boundary between vacuum and a medium is given by

$$E = \alpha Z^2 \gamma\hbar\omega_p/3$$

We see that the probability to emit energetic transition radiation photons, and the total amount of energy emitted by this effect, is indeed quite small. But if a charged particle penetrates through a stack with a large number of thin foils, or through material with a foam-like structure, there can be a large number of transitions, and the effect becomes significant. All the above equations are valid only if the thickness of the foils, and the thickness of the gaps between the foils, is larger than a ‘formation length’ given by  $\gamma c/\omega_p$ . For  $\gamma = 1,000$  this ‘formation length’ is about  $10 \mu\text{m}$ .

The energy emitted is proportional to  $\gamma$ , and for particles with  $\gamma = 1,000$  the energy of the photons is in the soft X-ray region. This effect is interesting because it can be used for the identification of particles. It is most useful for the identification of electrons.

Also for thin foils the total amount of energy radiated by the transition radiation effect is much smaller than the amount of energy emitted by the bremsstrahlung effect discussed below. But the bremsstrahlung power spectrum is almost constant up to the energy of the radiating particle, and therefore much harder. In the range of the typical transition radiation energy, the number of photons emitted by transition radiations is much larger than the number of photons emitted by bremsstrahlung.

**Bremsstrahlung.** Any charged particle undergoing acceleration will emit electromagnetic radiation. If a high-energy charged particle deviates from its trajectory due to a collision with a nucleus, this collision is necessarily accompanied by electromagnetic radiation. The emission is strongly peaked in the direction of flight of the charged particles.

The intensity of the radiation emitted can be calculated from first principles using quantum electrodynamics. In the case of particles other than electrons or positrons this emission is negligible, except at very high energy. For electrons or positrons, the amount of radiation emitted is also governed by the quantity ‘radiation length’  $X_0$  introduced in Eq. (2.3). The average energy loss due to bremsstrahlung by an electron of energy  $E$ , in a thickness of matter  $dx$ , is given by

$$\frac{dE}{dx} = -\frac{E}{X_0} \quad (2.9)$$

In a thin foil the photons have a  $1/E$  energy spectrum, and photons with energy of up to the total energy of the charged particle do occur. The power spectrum of the radiation is therefore a constant extending up to the energy of the radiating particle. For very high energy ( $E > 1$  TeV) this power spectrum becomes peaked towards high energy. The emission of photons is a stochastic process, Eq. (2.9) giving only the average energy radiated.

We notice that the energy loss due to bremsstrahlung is proportional to the energy of the charged particle. For electrons, the energy loss due to bremsstrahlung exceeds the energy loss due to ionisation above some critical energy  $E_c$ . This critical energy depends on the nuclear charge of the atoms in the medium and is approximately given by  $E_c = [800 \text{ MeV}]/(Z + 1.2)$ . For a particle of mass  $M$ , other than an electron, bremsstrahlung is suppressed by a factor  $(m_{\text{electron}}/M)^2$ . Therefore, for all particles other than electrons or positrons, bremsstrahlung is negligible at energies below 1 TeV.

The average energy of an electron that is losing energy according to Eq. (2.8) is given by

$$E(x) = E_0 e^{-\frac{x}{X_0}}$$

In the above equation,  $x$  represents the distance travelled in the medium. In one radiation length, an electron of more than 10 MeV loses about half of its energy in the form of bremsstrahlung.

**Overview of the electromagnetic interactions of charged particles.** The electromagnetic interactions of charged particles with a kinetic energy in the range 100 keV to a few 10 MeV are summarised below.

*Electrons:* Electrons lose energy by exciting and ionising atoms along their trajectory. Per centimetre, electrons will lose about 2 MeV multiplied by the density. Electrons typically travel several centimetres before losing all their energy. The trajectories of electrons are erratically twisted due to multiple scattering. They will also lose a significant fraction of their energy by bremsstrahlung, particularly at higher energies. If the energy exceeds 264 keV, electrons show Cherenkov radiation in water.

*Positrons:* Positrons behave in exactly the same way as electrons except that, after coming to rest, a positron will annihilate with electrons that are always present. This annihilation gives rise to a pair of back-to-back gamma rays of 511 keV.

*Alpha particles:* The energy loss of alpha particles is much larger than that of electrons. It is of the order of 1000 MeV/cm times the density of the medium. As a result, alpha particles travel only tens of microns in solids and a few centimetres in gases. The trajectory of alpha particles is approximately straight.

*Protons:* Protons ionise much more than electrons but less than alpha particles. The range in solids is of the order of 1 mm. The trajectory of protons is approximately straight.

*Nuclear fragments:* Nuclear fragments show extremely high ionisation, and therefore the range of such nuclear fragments is typically only a few microns long.

For charged particles with a much larger energy than 10 MeV, the range before the particles have lost all their energy will be much greater. The energy loss will be of the order of 2 MeV/cm times the density of the medium for  $Z = 1$  particles. A particle of 1 GeV will travel several metres in a solid before it has lost all its energy in excitation and ionisation of the atoms on its trajectory.

The energy loss of muons as a function of the momentum is illustrated in Fig. 2.13. The plot covers the whole range, from  $E_{\text{kinetic}} \approx 1$  eV to 100 TeV. Remember that, if the energy of the particle is much larger than the mass, the energy and the momentum become the same. Since a muon is immune to the strong colour force, it will almost never undergo a nuclear interaction. A high-energy muon can travel several kilometres in solid matter before losing all its energy. If the energy of the muon is above 1 TeV ( $10^{12}$  eV) it will lose most of its energy through bremsstrahlung. If the energy is between a few 100 MeV and 1 TeV, it will lose energy at a rate of  $\approx 2$  MeV/cm times the density of the medium.

Around  $P \approx 1$  MeV/c, the velocity of the muon becomes comparable to the velocity of electrons in atoms, and the Bethe–Bloch equation no longer holds. Starting from zero momentum, the energy loss will first increase, reach a maximum around  $P = 1$  MeV/c, and then decrease again.

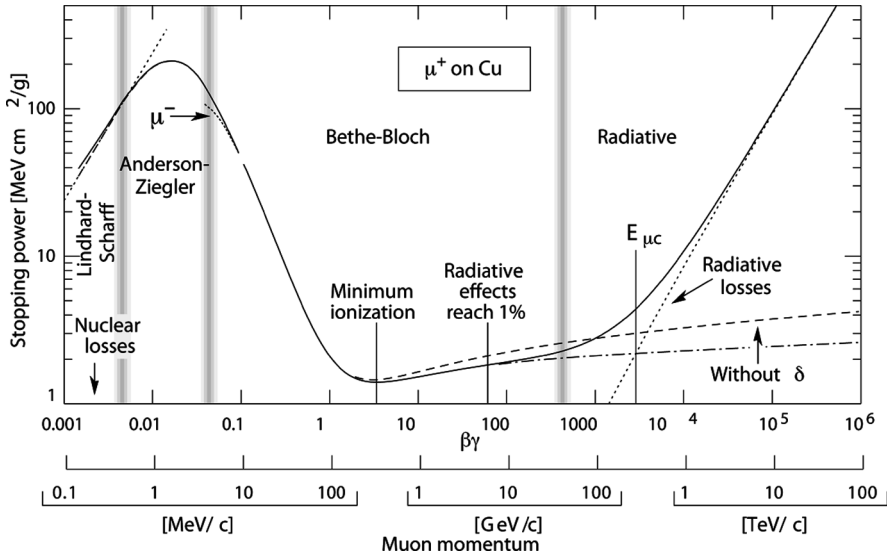


Fig. 2.13 Energy loss of a muon in copper between 100 keV and 100 TeV. Figure reproduced from Ref. [6] in Chap. 1, with permission

## 2.4 Interactions of X-Rays and Gamma Rays in Matter

X-rays and gamma rays are both high-energy photons. In the energy range 1–100 keV, these photons are usually called X-rays and above 100 keV they are usually called gamma rays. Some authors use the term ‘gamma rays’ to refer to any photon of nuclear origin, regardless of its energy. In these notes, I often use the term ‘gamma ray’ for any photon of energy larger than 1 keV. In the next few sections, the interactions of gamma rays with matter are discussed.

**Photoelectric effect.** If a charged particle penetrates in matter, it will interact with all electrons and nuclei on its trajectory. The energy and momentum exchanged in most of these interactions are very small, but together, these give rise to the different processes discussed in the previous chapter. When a photon penetrates in matter, nothing happens until the photon undergoes one interaction on one single atom. Gamma rays can interact with matter in many different ways, but the only three interaction mechanisms that are important for nuclear measurements are the photoelectric effect, the Compton effect and the electron–positron pair creation.

In the photoelectric absorption process, a photon undergoes an interaction with an atom and the photon completely disappears. The energy of the photon is used to increase the energy of one of the electrons in the atom. This electron can either be raised to a higher level within the atom or can become a free photoelectron. If the energy of gamma rays is sufficiently large, the electron most likely to intervene in the photoelectric effect is the most tightly bound or K-shell electron. The photoelectron then appears with an energy given by

$$E_{\text{kinetic}} = \hbar\omega - E_{\text{binding}}$$

In this equation, ' $E_{\text{binding}}$ ' represents the binding energy of the electron. In addition to a photoelectron, the interaction also creates a vacancy in one of the energy levels of the atom. This vacancy is quickly filled through rearrangement of the electrons; the excess energy being emitted as one or more X-rays. These X-rays are usually absorbed close to the original site of the interaction through photoelectric absorption involving less tightly bound electrons. Sometimes the excess energy is dissipated as an Auger electron instead of X-rays. In the Auger process, an electron from the outer shell falls into the deep vacancy, and another electron from the outer shell is expelled from the atom and takes up the excess energy.

The photoelectric effect is the dominant mode of interaction of the gamma rays of energy less than 100 keV. The energy dependence of the cross section is very approximately given by

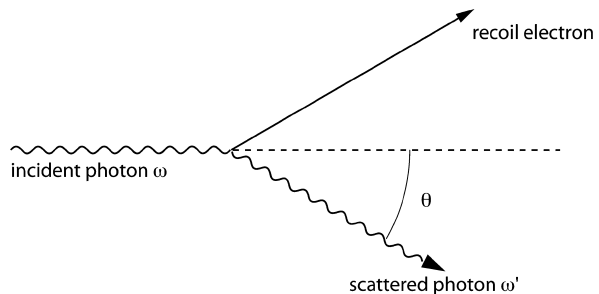
$$\sigma \approx \text{Const} \frac{Z^n}{E_\gamma^{3.5}}$$

In this equation,  $Z$  represents the charge of the nucleus and  $E$  the energy of the X-ray. The coefficient ' $n$ ' varies between 4 and 5 over the energy range of interest. The photoelectric cross section is a steeply decreasing function of energy (see Fig. 2.17). Every time the photon energy crosses the threshold corresponding to the binding energy of a deeper layer of electrons, the cross section suddenly increases. Such jumps in the cross section are clearly visible in Figs. 2.17 and 2.18.

**Compton scattering.** Compton scattering is the elastic collision between a photon and an electron. This process is illustrated in Fig. 2.14. This is a process that can only be understood from the point of view of quantum mechanics.

A photon is a particle with energy  $\hbar\omega$ . From Eq. (1.1), we know that the photon has an impulse momentum  $\hbar\omega/c$ . Energy and momentum conservation constrain the energy and the direction of the final state photon. Using energy and momentum conservation, it is straightforward to show that the following relation holds (see Exercise 2):

$$\hbar\omega' = \frac{\hbar\omega}{\left(1 + \frac{\hbar\omega}{m_e c^2} (1 - \cos \theta)\right)} \quad (2.10)$$



**Fig. 2.14** Illustration of Compton scattering and definition of the scattering angle  $\theta$

By using straightforward energy conservation, we ignore the fact that the electrons are not free particles but are bound in the atoms, and this will cause deviations from the simple expression above.

The value of the Compton scattering cross section for photon collisions on free electrons can only be derived from a true relativistic and quantum mechanical calculation. It is known as the Nishina–Klein formula (see Ref. [4] and references therein).

$$\frac{d\sigma}{d\Omega} = \frac{r_0^2}{2} \left( \frac{\hbar\omega'}{\hbar\omega} \right)^2 \left( \frac{\hbar\omega}{\hbar\omega'} + \frac{\hbar\omega'}{\hbar\omega} - \sin^2\theta \right) \quad (2.11)$$

Equation (2.11) gives the differential cross section for the Compton scattering into a solid angle  $d\Omega$ . Integration over all angles gives the total cross section  $\sigma$ . The result of the integration is given in Ref. [4]. For energies either much larger or much smaller than the electron mass, a simple and compact expression for the total cross section is obtained.

$$\sigma = \frac{8\pi}{3} r_0^2 \quad \hbar\omega \ll m_e c^2$$

$$\sigma = r_0^2 \pi \frac{m_e c^2}{\hbar\omega} \left[ \ln \left( \frac{2\hbar\omega}{m_e c^2} \right) + \frac{1}{2} \right] \quad \hbar\omega \gg m_e c^2$$

In these formulas,  $r_0$  represents the classical electron radius introduced in Sect. 1.2. We see that for photon energies below the mass of the electron, the Compton cross section is independent of energy, and for photon energies above the electron mass, the cross section decreases as  $(\text{energy})^{-1}$ .

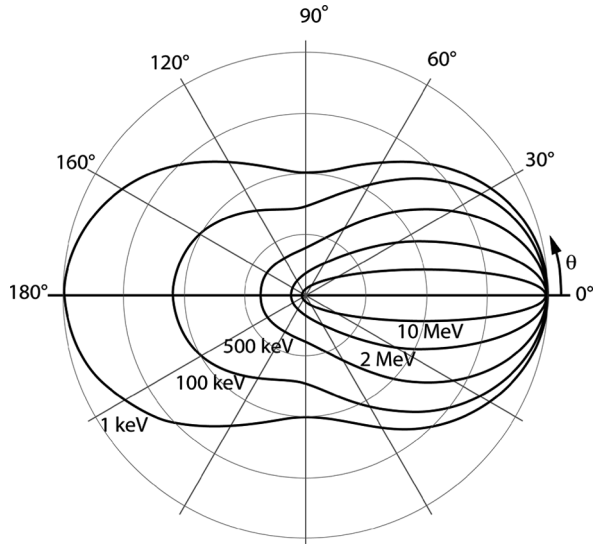
The Nishina–Klein formula only applies to scattering of gamma rays from free electrons. If the photon energy is much larger than the binding energy of electrons in atoms, the effects due to this binding are small.

If the gamma energy is small, there is a large probability that the recoil electron remains bound in the atom after the collision. The atom as a whole takes up the energy and the momentum transferred to the electron. In this case the interaction is called coherent Compton scattering or Rayleigh scattering. If the Compton interaction ejects the electron from the atom, the interaction is called incoherent Compton scattering.

The angular distribution of Compton scattering described by Eq. (2.11) is illustrated in Fig. 2.15. For photon energies much below the electron mass, the scattering is rather isotropic and back-scattering is about as likely as scattering in the forward direction. If the photon energy is much larger than the electron mass, the scattering is peaked into the forward direction.

**Pair production.** If the energy of the photon is at least two times larger than the mass of an electron, the energy of the photon can be used to create an electron and positron pair. This process is illustrated in Fig. 2.16. However, this reaction is not possible in empty space. In fact, energy and momentum cannot be conserved in this process. To see this, just imagine that the reaction  $\gamma \rightarrow \text{electron} + \text{positron}$

**Fig. 2.15** A polar plot of the cross section for Compton scattering. The curves show the magnitude of the differential cross section as a function of the scattering angle for different values of the incident photon energy. Figure calculated with Eq. (2.11).

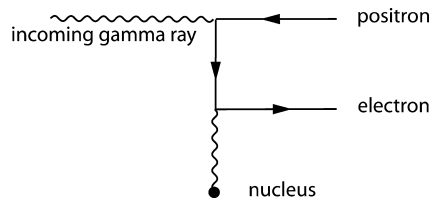


could take place. In that case it would be possible to go to the centre of mass system of the final state electron–positron pair. In that system, the sum of the impulse moments of the electron and the positron is zero. Therefore, the original gamma ray should have zero momentum. This is impossible. However, if the reaction  $\gamma \rightarrow \text{electron} + \text{positron}$  happens in the strong electric field of the nucleus, the nucleus can take up momentum, and in this way the energy and momentum can be conserved and the reaction becomes possible.

The cross section for pair production is given in Ref. [4]. It rises quickly from the threshold value of  $2 m_e$  to a constant value at high energy, as is illustrated in Fig. 2.17. The high-energy limit of the cross section is given by

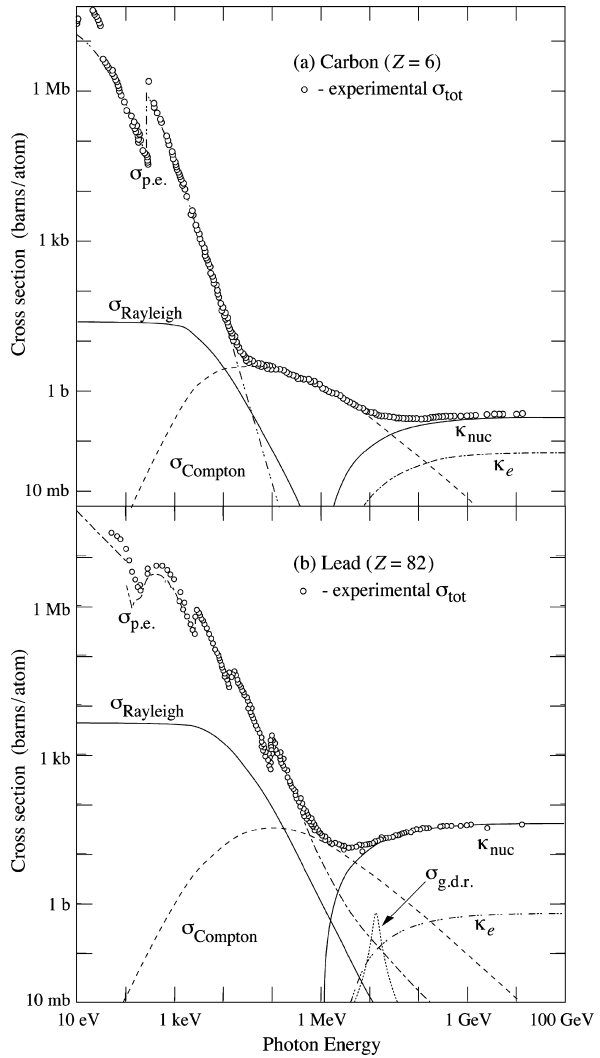
$$\sigma = \frac{7}{9} 4\alpha r_0^2 Z_{nucl} (Z_{nucl} + 1) \ln \left( \frac{183}{3\sqrt{Z_{nucl}}} \right)$$

The expression above reminds us of the quantity ‘radiation length’  $X_0$  introduced in Sect. 2.3. From the above expression of the cross section it immediately follows that, if a beam of high-energy photons penetrates in a medium, the number of unconverted gamma rays will decrease according to



**Fig. 2.16** An electron–positron pair can only be created if a certain amount of momentum can be exchanged with the nucleus

**Fig. 2.17** Photon total cross sections as a function of energy in carbon and lead, showing the contributions of different processes:  $\sigma_{p.e.}$  = Atomic photoelectric effect (electron ejection, photon absorption);  $\sigma_{\text{Rayleigh}}$  = Coherent scattering (Rayleigh scattering/atom neither ionised nor excited);  $\sigma_{\text{Compton}}$  = Incoherent scattering (Compton scattering off an electron);  $k_{\text{nuc}}$  = Pair production, nuclear field;  $k_e$  = Pair production, electron field;  $\sigma_{g.d.r.}$  = Photonuclear interactions, most notably the Giant Dipole Resonance. Figure reproduced from Ref. [6] in Chap. 1, with permission



$$\frac{7 dx}{e \cdot 9 X_0}$$

Therefore, in one radiation length, a high-energy gamma ray has a 54% chance of converting into an electron–positron pair.

**Overview of the interactions of gamma rays.** It is convenient to consider three energy ranges when discussing gamma interactions:

- In the range 1–100 keV, the interactions are dominated by the photoelectric effect. The mean free path in water varies from about one micron at 1 keV to several

centimetres at 100 keV. The cross section strongly depends on the charge of the nucleus.

- In the range 100 keV–1 MeV, the Compton scattering process dominates the cross section. The mean free path rises slowly and is about 10 cm in water at 500 keV.
- At energies above 1 MeV, the pair creation process dominates the cross section. The mean free path of gamma rays of very high energy is equal to (9/7) times the radiation length.

If a beam of photons with intensity  $I_0$  enters matter, the intensity  $I(x)$  will satisfy the following equation (see Sect. 2.1):

$$\frac{dI(x)}{dx} = -I(x)N\sigma$$

The cross section  $\sigma$  is the sum of the cross section for the photoelectric effect, the Compton effect and the pair creation effect. It is customary to write this in terms of the linear attenuation coefficient  $\mu$  defined as  $\mu = N\sigma$ . Obviously, the total linear attenuation coefficient is the sum of the linear attenuation coefficients for the photoelectric effect, the Compton effect and the pair creation effect

$$\frac{dI(x)}{dx} = -I(x)\mu$$

The intensity of the unscattered beam and the photon mean free path are therefore given by

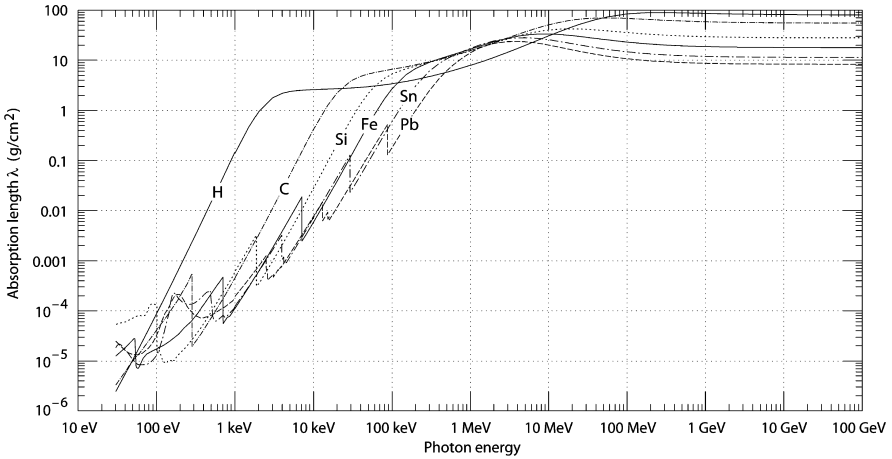
$$I(x) = I_0 e^{-x\mu}, \quad \lambda = \frac{1}{\mu}$$

One should be aware of the fact that the Compton scattering does not remove the photons. They just lose some energy and change direction. In the literature, and in particular in numerical tables, the following quantities are often used.

$$\begin{aligned} \frac{\mu}{\rho} &: \text{photon mass attenuation coefficient} \\ \frac{\rho}{\mu} &= \lambda\rho: \text{photon mass attenuation length} \end{aligned}$$

Figure 2.18 shows the photon mass attenuation length of several materials as a function of the photon energy.

Gamma rays with energies much above 1 MeV will cause electromagnetic showers. On average in about one radiation length the original gamma ray gives rise to an electron–positron pair. This electron and positron will create a large number of secondary gamma rays by bremsstrahlung. In one radiation length, an electron or a positron will radiate about half of its energy in this way. Many of these secondary gamma rays will again create electron–positron pairs, and these will again undergo bremsstrahlung and so on. If the energy of the initial gamma ray is large enough,



**Fig. 2.18** The photon mass attenuation length  $\lambda\rho = 1/(\mu/\rho)$  for various elemental absorbers as a function of photon energy. The intensity  $I$  remaining after traversal of thickness  $t$  (in mass/unit area) is given by  $I = I_0 \exp(-t/\lambda)$ . The accuracy is a few percent. For a chemical compound or mixture,  $1/\lambda_{\text{eff}} \approx \sum_{\text{elements}} w_Z/\lambda_Z$ , where  $w_Z$  is the proportion by weight of the element with atomic number  $Z$ . Figure reproduced from Ref. [6] in Chap. 1, with permission

the number of particles in the shower will grow exponentially. But at each step the average energy of the particles in the shower decreases, and fewer of the secondary gamma rays have sufficient energy to produce electron–positron pairs. The number of the particles in the shower will reach a maximum and start decreasing; eventually all electrons, positrons and gamma rays are absorbed or stopped.

### 2.5 Interactions of Particles in Matter due to the Strong Force

A proton or a neutron has an apparent size of slightly more than  $10^{-13}$  cm, and the cross section for the collision on another proton or a neutron is therefore expected to be  $\approx 4 \times 10^{-26}$  cm<sup>2</sup>. A nucleus with atomic number  $A$  has a diameter that is  $(A)^{1/3}$  times the proton diameter and a geometrical cross section that is  $(A)^{2/3}$  times that of a proton. The cross section for the interaction of a proton on a nucleus of atomic number  $A$  is therefore expected to be

$$\sigma \approx 4 \times 10^{-26} (A)^{2/3} \text{ cm}^2$$

The mean free path for protons in material with atomic number  $A$  is therefore

$$\lambda = \frac{1}{N\sigma} \approx \frac{A^{1/3}}{\rho} \frac{1}{N_A 4 \times 10^{-26}} \approx \frac{A^{1/3}}{\rho} 35 \text{ g/cm}^2$$

In this last equation,  $N_A = 6.022 \times 10^{23}$  represents the Avogadro number, and we used the fact that the number of scattering centres per unit volume  $N$  is given by  $N = \rho(N_A/A)$ . The mean free path for protons calculated above is sometimes called the ‘hadronic interaction length’. The calculation above gives a value for the numerical coefficient slightly larger than  $35 \text{ g/cm}^2$ . The value  $35 \text{ g/cm}^2$  is by convention taken in the definition of the hadronic interaction length.

However, this very simplistic argument cannot be correct. Quantum mechanics is essential for the understanding of phenomena at this dimension scale. Indeed, in quantum mechanics a wave is associated with every particle, and the wavelength is given by  $\lambda = h/P$ . If this wavelength is small compared to the size of the nucleus, we should indeed expect the simplistic conclusion above to be a fair approximation. However, a proton with a kinetic energy of 10 MeV has a momentum  $cP = 137 \text{ MeV}$ , and the quantum mechanical wavelength associated with such a proton is  $\approx 10 \times 10^{-15} \text{ m}$  (remember  $hc = 2\pi \cdot 197 \times 10^{-15} \text{ MeV m}$ ). This is comparable to or larger than the size of a nucleus, and quantum mechanics is expected to be very important. At energies above  $\approx 1 \text{ GeV}$ , the wavelength associated with the proton becomes small compared to the size of a nucleus, and the simplistic result is, indeed, more or less correct. Particles with a kinetic energy above  $\approx 1 \text{ GeV}$  are usually referred to as ‘high-energy particles’.

At nuclear energies, the proton–nucleus cross section will deviate substantially from the result derived above because of the effects of quantum mechanics. In addition, at low energy the electrostatic repulsion between the positive proton and the positive charge of the nucleus will prevent the proton and the nucleus from approaching each other sufficiently for a nuclear interaction to occur. This electrostatic repulsion strongly suppresses nuclear interactions at energies below a few 100 keV (see Exercise 3). The effect of this electrostatic repulsion is negligible if the energy of the proton is much larger than 100 keV.

At high energy all hadrons, on average, undergo a nuclear interaction after a distance approximately equal to the hadronic interaction length. This mean free path is in the range 10–100 cm in solids. A very high-energy proton will lose a few MeV per cm due to ionisation in a solid, and the range of the proton due to the energy loss will be larger than the hadronic interaction length. The proton will most of the time undergo a nuclear interaction before it has lost all its energy in ionisation. In such a nuclear interaction the target nucleus will be broken up. The nuclear fragments produced in this way are usually very unstable, and return to a stable condition in several steps. One particular case that needs to be mentioned is the collision of a high-energy proton with a very heavy nucleus. A very heavy nucleus has many more neutrons than protons. For example, lead has 82 protons and  $\approx 125$  neutrons. Nuclei with atomic charge up to about 20 have approximately equal numbers of protons and neutrons. For larger atomic charges, the neutron excess slowly increases with increasing nuclear mass. If a very heavy nucleus is broken up in a collision with a high-energy proton, the fragments will quickly expel their excess neutrons and a large number of secondary neutrons are produced. A proton of 1 GeV will, on average, produce  $\approx 25$  neutrons in a heavy target such as lead. This process of neutrons production is called spallation, and it is an efficient way to produce neutrons.

In addition to breaking up the nucleus, the high-energy protons will also undergo a violent collision with one or more protons or neutrons in the nucleus. In this collision a number of additional hadrons is produced. At a few GeV of energy, only a handful of secondary hadrons are produced, and this number increases slowly with energy. Typically 90% of the secondary particles produced are pions, with approximately equal numbers of  $\pi^+$ ,  $\pi^-$  and  $\pi^0$ . Also other hadrons can be produced, but the probability of production decreases rapidly with increasing mass. If the energy of the primary proton is large enough, these pions and other hadrons will also have sufficient energy to produce further nuclear interactions, and an avalanche of hadrons is produced.

**Photonuclear interactions.** The term photonuclear interaction refers to the strong interaction of a gamma ray with a nucleus. It may come as a surprise that gamma rays can undergo strong interactions, since it is the very nature of gamma rays to be insensitive to the strong force. The explanation is that the strong interactions of gamma rays are an indirect effect. Indeed, a gamma ray in matter will create particle–antiparticle pairs for any elementary charged particle that exists. As for the case of the production of electron–positron pairs, this reaction is impossible because of energy and momentum conservation. However, if the produced particles only need to live a short time and exchange some energy and momentum with a nucleus, these reactions become possible. One can see strong interactions of a gamma ray as first the production of a quark–antiquark pair, and subsequently the interaction of this virtual quark pair with the nuclei in matter. The quark–antiquark pair is sensitive to the strong colour force and interacts with matter in the same way as any other hadron. The strong interactions of gamma rays are very similar to the strong interactions of any other hadron, except that the cross sections are a factor  $\approx 100$  lower. Below about 1 GeV, the cross section shows strong resonant behaviour. Above about 1 GeV, the cross section is fairly energy independent. Below 10 MeV, the photonuclear cross sections are extremely small because of the mismatch between the energy needed to create the virtual quark–antiquark pair and the energy available in the gamma rays.

**Neutron interactions.** Similar to the photon, the neutron lacks an electric charge, and therefore it is not subject to Coulomb interactions with electrons and nuclei in matter. A neutron will penetrate in matter until it undergoes a strong interaction with a nucleus. Because of the marked difference in the behaviour of the neutrons, it is customary to refer to neutrons as ‘high-energy neutrons’, ‘fast neutrons’ and ‘slow neutrons’, depending on their energy.

High-energy neutron means a neutron with energy larger than 1 GeV. As far as strong interactions are concerned, a high-energy neutron will behave in a very similar way as a high-energy proton, and the mean free path is of the order of the hadronic interaction length.

The neutrons produced in a nuclear reactor typically have between 100 keV and 10 MeV of energy. These are called fast neutrons. At these energies, the neutron–nucleus cross sections are often very different from the cross sections at higher energies. In addition, neutron–nucleus cross sections show a very strong energy dependence. Many neutron interactions are characterised by resonances, i.e. the

cross section for a certain type of interaction shows a pronounced peak at a particular energy. At the resonance, the cross section can be many orders of magnitude larger than at slightly higher or lower energy. This is illustrated in Fig. 3.1 showing the energy dependence of the neutron capture cross section in uranium and plutonium.

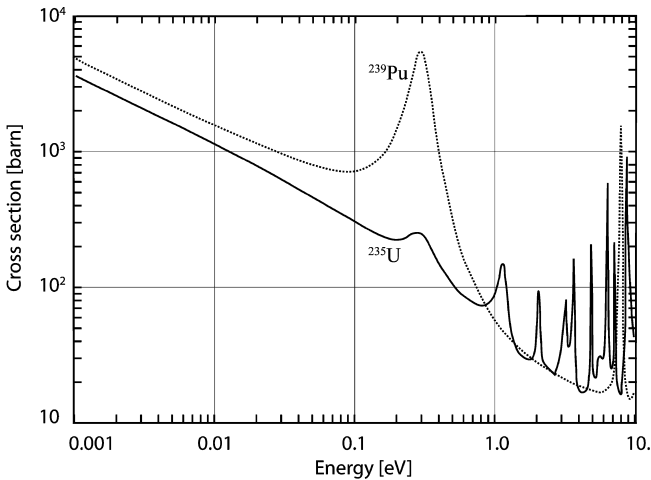
For fast neutrons, the most probable way of interacting is by elastic scattering on the nuclei of the medium. The energy loss of neutrons is mainly due to elastic scattering, but neutrons can also interact in other ways with nuclei:

- (1) Inelastic scattering: the nucleus is left in an excited state, which later decays by gamma emission or some other forms of radiation. This process will only become significant for neutrons with more than 1 MeV of energy.
- (2) Radiative neutron capture: the nucleus absorbs the neutron and finds itself in an excited state, which decays by gamma emission.
- (3) Neutron capture followed by emission of a charged particle or followed by fission.

Fast neutrons will undergo elastic collisions and lose their kinetic energy until the energy is equal to the thermal energy of surrounding matter. The thermal energy is equal to  $3/2 kT$ , with  $kT \approx 25$  meV at room temperature. In the hot environment of a nuclear reactor, thermal energy will, of course, correspond to the temperature in the reactor core.

‘Slow neutrons’ usually refers to neutrons with energy less than 0.5 eV.

For slow neutrons the most probable interactions are elastic scattering and neutron capture. The elastic scattering will reduce the energy of slow neutrons further



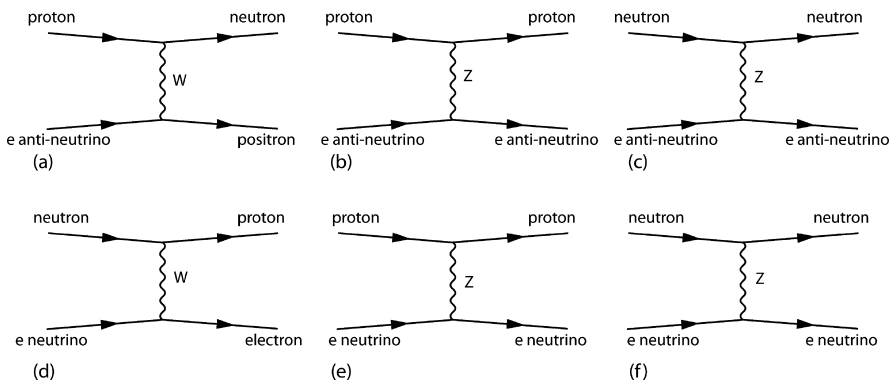
**Fig. 2.19** Fission cross section of  $^{235}\text{U}$  and  $^{239}\text{Pu}$  as a function of energy. Both cross sections become very large at thermal energies. The cross sections show characteristic resonance peaks at certain energies. The data for this figure were obtained from Ref. [8] in Chap. 1

until they have on average the thermal energy ( $3/2 kT$ ). For many isotopes the capture cross section is inversely proportional to the speed of the neutron, and becomes very large for thermal neutrons. This is, for example, the case for  $^{235}\text{U}$  and  $^{239}\text{Pu}$  as illustrated in Fig. 2.19.

## 2.6 Neutrino Interactions

Figure 2.20 shows the different ways electron neutrinos can interact in matter. In this figure, the interactions are shown as interactions on protons and neutrons; the underlying quark diagrams can be found in analogy with Fig. 1.5. These reactions can occur on free neutrons and protons, or on neutrons and protons bound in nuclei. It is straightforward to find the list of possible reactions by requiring conservation of the electric charge at the vertices, and by requiring that an electron neutrino can only turn into an electron, and an electron anti-neutrino can only turn into a positron. Similar diagrams can be drawn for muon neutrinos and for  $\tau$ -neutrinos. The only difference is that the muon neutrino gives rise to a muon, and a  $\tau$ -neutrino to a  $\tau$ -lepton. In addition, neutrinos and anti-neutrinos can also scatter on the electrons present in matter. The reactions mediated by the exchange of W-bosons are called ‘charged current’ interactions, and the reactions mediated by the exchange of Z-bosons are called neutral current interactions.

The probability that a neutrino will interact with matter is extremely small. A neutrino has no electric charge and is not sensitive to strong interactions; it is only sensitive to weak interactions. A neutrino penetrating in matter will only interact when it comes within a distance of  $10^{-18}$  m of one of the quarks present in the neutrons or protons inside the nuclei. Forgetting quantum mechanics, we would be tempted to say that the cross section for neutrino collisions in matter is of the order of  $10^{-36}$  m<sup>2</sup>, and the corresponding mean free path in matter is of the



**Fig. 2.20** Diagrams for the possible interactions of electron neutrinos in matter. Similar diagrams exist for muon neutrinos and  $\tau$ -neutrinos. These diagrams are not proper quantum field theory diagrams and the arrows represent the direction of motion of the particles

order of several 1000 km. This argument is completely wrong, because it is essential to use quantum mechanics and the correct description of neutrino interactions. However, also when all this is taken into account, neutrinos indeed have a very small probability of interacting.

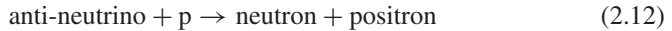
At high energy, all neutrino cross sections are of similar magnitude and increase linearly with the energy of the neutrino. For neutrinos of  $\approx 10^{11}$  GeV the cross section is close to the naive expectation above, but the cross section continues to rise for higher energy. At this extremely high energy, the cross section is no longer increasing linearly with the energy of the neutrino.

The daughter nuclei produced in a fission reaction are neutron rich and undergo several  $\beta^-$  decay processes before becoming stable. In a  $\beta^-$  decay a neutron in the nucleus becomes a proton through the reaction



In a nuclear reactor, on average about six anti-neutrinos are produced per fission. Because of the nuclear effects, the energy spectrum of the anti-neutrinos is not the same as the energy spectrum from the decay of a free neutron. The energy spectrum extends from zero to  $\approx 8$  MeV, and the average energy is  $\approx 1.5$  MeV. The instant energy released in the fission of one  $^{235}\text{U}$  isotope is 187 MeV, neutrino energy not included. An additional 9 MeV is carried away by the neutrinos. The total electron anti-neutrino flux near a nuclear reactor of 3 GW thermal power is therefore  $\approx 1.5 \times 10^{21}$  per s. The exact number of anti-neutrinos and their energy spectrum depends on the relative importance of the different fissile isotopes in the reactor.

These anti-neutrinos can be observed through the inverse reaction shown in Fig. 2.20(a)



On a free proton this reaction is only possible if the energy of the anti-neutrino exceeds 1.804 MeV, because the mass of a neutron plus the mass of a positron is larger than the mass of a proton by this amount. Well above the energy threshold the cross section increases linearly with the neutrino energy  $E_\nu$ , and is given by

$$\sigma = 6.7 \times 10^{-42} \times E_\nu [\text{MeV}] \text{ cm}^2.$$

For anti-neutrinos produced in a nuclear reactor, the cross section for reaction (2.12) on free protons is smaller because the energy is only just above the threshold. On average, for anti-neutrinos produced in a reactor, the cross section is  $\sigma \approx 10^{-43} \text{ cm}^2$ . The mean free path of such anti-neutrinos in normal solid matter is therefore of the order of one light year! Nevertheless, at a distance of  $\approx 25$  m from the core of a 3 GW reactor there will be about 500 such anti-neutrino interactions/hour in  $1 \text{ m}^3$  of water. It is therefore quite possible to observe neutrino interactions. The difficulty is in distinguishing the anti-neutrino interactions from the much more abundant events caused by several other processes such as cosmic

rays and natural radioactivity in the detector or in the surrounding materials. The observation of reaction (2.12) at the Savannah river nuclear reactor by Reines and Cowan in 1959 [3] provided the first direct evidence for the existence of the neutrino. Such detectors could be used to monitor the fissile isotope inventory in a reactor core. Reaction (2.12) can also occur on a proton bound in a nucleus. In that case, the positron is expelled from the nucleus and the charge of the nucleus is lowered by one unit. The new nucleus thus formed is usually unstable.

The Sun produces energy by the fusion of hydrogen into helium. This requires the conversion of protons into neutrons in the reaction:



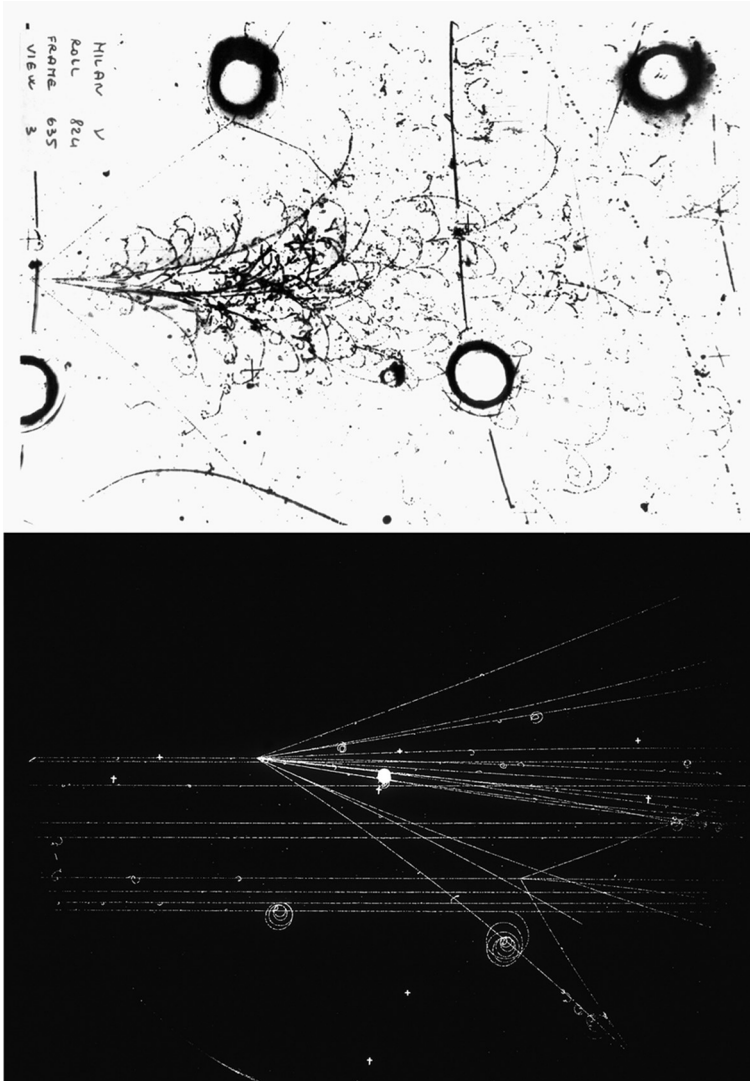
This reaction cannot occur if the neutron remains a free particle. However, if the neutron becomes part of a helium nucleus, the reaction is indeed possible. The Sun is therefore a source of electron neutrinos, not anti-neutrinos. The neutrinos from the Sun have also been observed. Because the neutrino flux from the Sun is much smaller than the neutrino flux close to a nuclear reactor, detecting these neutrinos requires very large detectors and a very careful control of the backgrounds.

High-energy particle accelerators also are intense sources of neutrinos. With accelerators not only electron neutrinos, but also muon neutrinos and  $\tau$  neutrinos can be produced.

There is a subtle quantum mechanical effect causing the different flavours of neutrinos to change as a function of the distance travelled. For example an electron neutrino, after travelling some distance, can become a muon neutrino and later can again become an electron neutrino. This phenomenon is called neutrino oscillations. The effect is related to the mass of the neutrinos. A discussion of this effect is beyond the scope of the present book.

## 2.7 Illustrations of the Interactions of Particles

Several of the effects discussed in the present chapter can be illustrated with the help of bubble chamber pictures. A bubble chamber is an instrument that allows visualising the trajectory of charged particles. This technique has been extensively used until approximately 1980 for studying the properties of subatomic particles at high energies. The principle is as follows. A liquid is brought to a temperature above its boiling point by a sudden drop of pressure with the help of a mechanical piston. The superheated liquid immediately begins to boil and the bubbles preferentially form at points where the temperature is slightly higher. Bubbles will therefore form along the tracks of charged particles because energy is deposited along the track, and this energy is causing local heating of the liquid. The bubbles will eventually grow to quite large dimensions, but after a few milliseconds the bubbles will only be a few tenth of a millimetre in diameter. If a picture is taken a few milliseconds after the passage of the track, the trajectories of charged particles become visible as a trail of small bubbles. In a bubble chamber, there usually is a magnetic field



**Fig. 2.21** (Top) A neutrino coming from the left interacts in the Gargamelle Bubble chamber filled with freon and produces two hadrons and a high-energy electron. The electron gives rise to an electromagnetic shower. (Bottom) Nine protons of 24 GeV enter the 30 cm hydrogen bubble chamber of CERN from the left. Two of the incoming protons interact with a hydrogen nucleus and produce secondary particles. The tightly spiralling tracks are electrons ejected from the hydrogen atoms by a high-energy particle. Images copyright CERN

perpendicular to the plane of the picture, and therefore all tracks bend clockwise to counter-clockwise depending on the charge.

The lower image in Fig. 2.21 shows a picture obtained with a bubble chamber filled with liquid hydrogen at a temperature of about 27 K. In liquid hydrogen the radiation length is  $\approx 9$  m and the hadronic interaction length is  $\approx 6$  m. The picture

shows a beam of protons with 24 GeV of energy entering the chamber from the left. Two of the protons collide with a hydrogen nucleus and produce a number of secondary particles, mostly pions. Because of the long radiation length in hydrogen, the tracks have very little multiple scattering and the trajectories are therefore nearly circles. Because of the energy loss, the curvature of the circles becomes smaller as the particle proceeds in the liquid. On the picture we notice several tracks originating on a high-energy track and completely curled up. These are electrons ejected for an atom by the high-energy track. The electron loses its energy and the radius of curvature becomes smaller and smaller until the electron stops

The upper image in Fig. 2.20 is a picture obtained with a bubble chamber filled with liquid freon. Freon is a general name for carbon-fluor compounds; in this case the freon used was  $\text{CF}_3\text{Br}$ . In this type of freon the radiation length is about 30 cm. The image corresponds to about 2 m in real space. In this picture a neutrino is coming from the left and interacting with a nucleus close to the left edge of the picture. In this interaction two hadrons are produced and one high-energy electron. The electron gives rise to a shower of electron–positron pairs and secondary gamma rays. Because of the much shorter radiation length compared to hydrogen, the tracks show much more multiple scattering in freon than in hydrogen. Therefore, the electron trajectories are erratically twisted and only vaguely resemble spirals.

## 2.8 Exercises

- (1) Calculate the approximate mean free path of a high-energy neutron in dry air. Air is 80%  $^{14}\text{N}$  and 20%  $^{16}\text{O}$  by volume.
- (2) Derive equation (2.10) using energy–momentum conservation.
- (3) Consider two protons with the same kinetic energy and travelling on a head-on collision trajectory. The protons repel each other by the Coulomb force. At the point of closest approach the distance between protons is  $2 \times 10^{-10}$  m. What is the energy of each of these protons?
- (4) Derive the expression for the threshold energy for the Cherenkov effect (Eq. 2.8) starting from  $E = \gamma m_0 c^2$ .
- (5) The diameter of atoms is of the order of the Bohr radius and is given by  $a = \frac{4\pi \epsilon_0 \hbar}{m_e e^2}$ . Use the Heisenberg uncertainty relation to argue that the velocity of the electrons in atoms is of the order  $v \approx \alpha c$ , where  $\alpha$  is the fine structure constant.

$$\alpha = \frac{e^2}{4\pi \hbar c \epsilon_0} \approx \frac{1}{137}.$$

## References

1. C.F. Williamson, J.P. Boujot and J. Picard, CEA-R3042 (1966).
2. J.D. Jackson, Classical electrodynamics, John Wiley & Sons (1975)
3. F. Reines and C. Cowan, Phys. Rev. 113, 273 (1959).
4. C. Leroy and P. Rancoita, Principles of radiation interaction in matter and detection, World Scientific (2004).